



Amfora Company
7145 Watt Ave., Ste. 5
North Highlands, CA-95660
U.S.A.
Tel. 1 800 515 1977 / 1 916 505 2722
Web; www.italartworld.com
Email; sales@italartworld.com



DESIGN ANTIQUARIATO



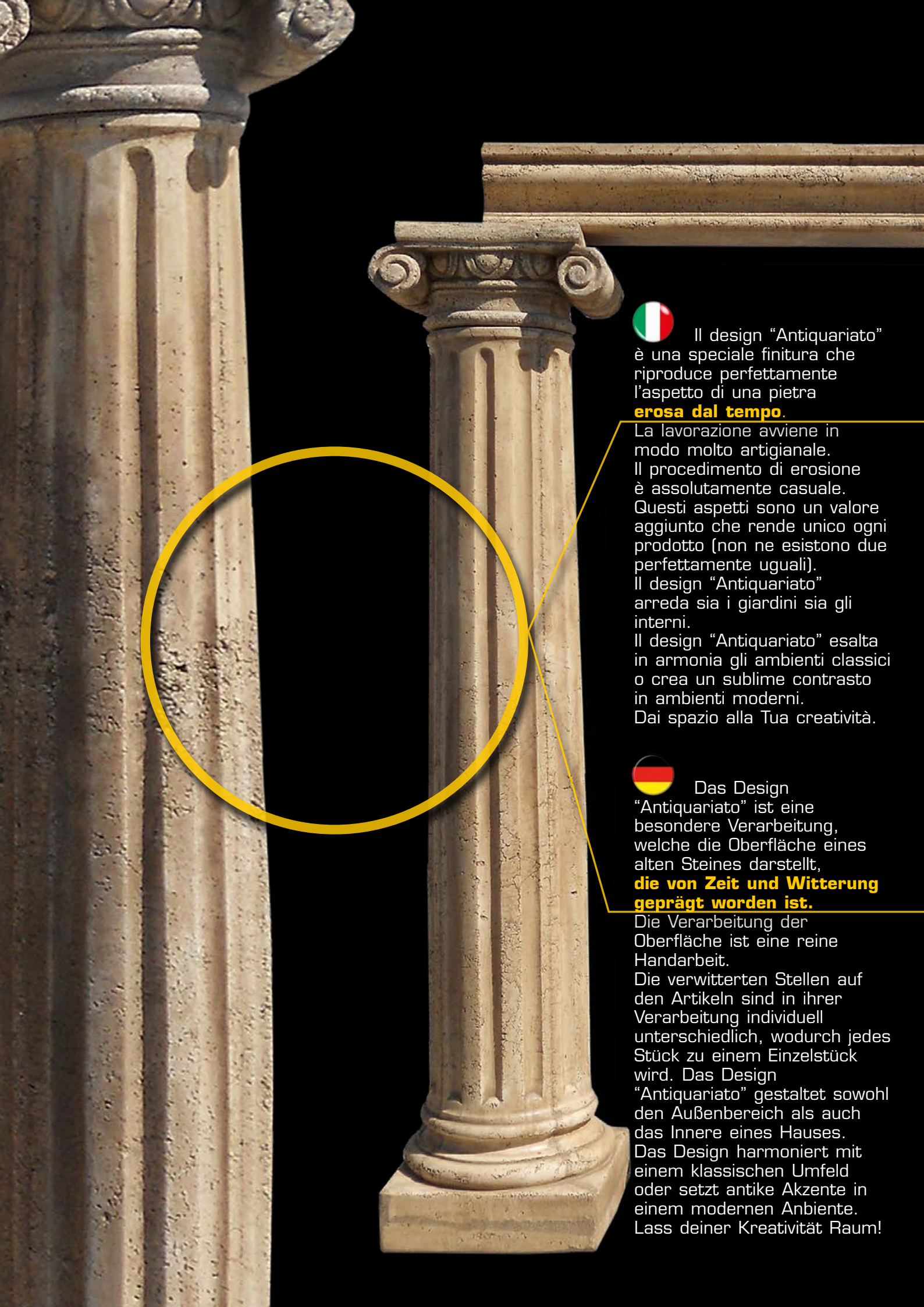

Il design "Antiquariato" è una speciale finitura che riproduce perfettamente l'aspetto di una pietra **erosa dal tempo.**

La lavorazione avviene in modo molto artigianale. Il procedimento di erosione è assolutamente casuale. Questi aspetti sono un valore aggiunto che rende unico ogni prodotto (non ne esistono due perfettamente uguali). Il design "Antiquariato" arreda sia i giardini sia gli interni. Il design "Antiquariato" esalta in armonia gli ambienti classici o crea un sublime contrasto in ambienti moderni. Dai spazio alla Tua creatività.



Das Design "Antiquariato" ist eine besondere Verarbeitung, welche die Oberfläche eines alten Steines darstellt, **die von Zeit und Witterung geprägt worden ist.**

Die Verarbeitung der Oberfläche ist eine reine Handarbeit. Die verwitterten Stellen auf den Artikeln sind in ihrer Verarbeitung individuell unterschiedlich, wodurch jedes Stück zu einem Einzelstück wird. Das Design "Antiquariato" gestaltet sowohl den Außenbereich als auch das Innere eines Hauses. Das Design harmoniert mit einem klassischen Umfeld oder setzt antike Akzente in einem modernen Ambiente. Lass deiner Kreativität Raum!



The “Antiquariato” design is a special finishing reproducing perfectly the aspect of a natural stone **eroded by the time.**

This is a very artisanal working and the eroding process is absolutely random. These aspects are an added value which makes each item really unique (is impossible to find two items perfectly identical). The “Antiquariato” design furnishes both the gardens and the interior. The “Antiquariato” design exalts with harmony the classic environments or creates a sublime contrast with modern spaces. Give space to your creativity.



Le style «Antiquariato» est une finition spéciale qui reproduit parfaitement **l'aspect d'une pierre érodée par le temps.**

Le traitement est réalisé à la main. Le processus d'érosion est totalement aléatoire. Ces aspects sont une valeur ajoutée qui rend chaque produit unique (il n'y en a pas deux qui soient identiques). Le style “Antiquariato” fournit à la fois les jardins et l'intérieur.

Le design «Antiquariato» exalte en harmonie les environnements classiques ou crée un contraste sublime dans les espaces modernes. Donnez espace à votre créativité.

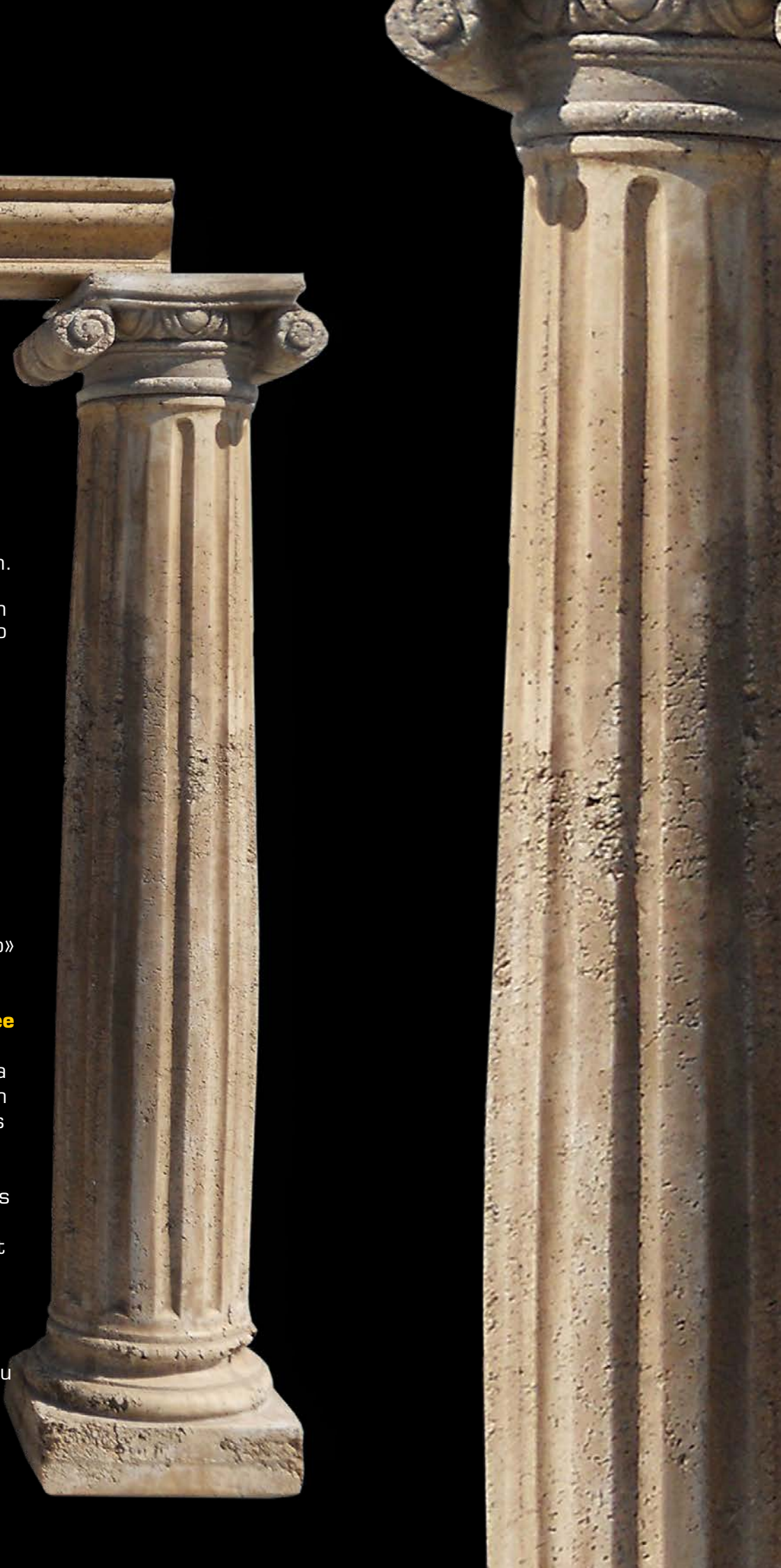



Art 10013

COPPIA BASI CAVOUR

h cm 76 - lung. cm 58x15 - peso kg 90
198 lbs - 29.9" tall - 22.8" L - 5.9" W



Art 10014

CAPITELLO FOGLIE GRANDE

h cm 76 - base cm 44x44 - peso kg 74
163,14 lbs - 29.92" tall
17.32" L - 17.32" W



Art 10015
COPPIA FOGLIE PICCOLO

h cm 41 - base cm 31x31
peso kg 25
55.11 lbs - 16.14" tall
12.20" L - 12.20" W



Art 10026
TAVOLO INTARSIO

h cm 45 - Ø cm 70 - peso kg 27
58.5 lbs - 17.7" tall - 27.6" dia



Art 10020
COPPIA BASI PERGAMENA

h cm 78 - base cm 32x43 - peso kg 76
167 lbs - 30.7" tall - 12.6" L - 6.9" W



5

Design Antiquariato



Art 10032
COPPIA CARIATIDI

h cm 81 - base cm 40x20
peso kg 68
145 lbs - 31.9" tall
15.7" L - 15.7" W



Art 10034
1/2 COLONNA IONICA

h cm 80 - base cm 19x34 - peso kg 21
46.29 lbs - 31.49" tall
7.48" L - 13.38" W



Art 10040
COPPIA BASE VENEZIA

h cm 72 - base cm 52x20 - peso kg 85
185 lbs - 28.3" tall - 20.5" L - 7.9" W



Art 10041
1/2 CAPITELLO GALLIPOLI
h cm 44 - Ø cm 38 - base cm 27x51
peso kg 26
57.32 lbs - 17.32" tall - 14.96 dia
10.62" L - 20.07" W



Art 10042
1/2 COLONNA GALLIPOLI
h cm 77 - Ø cm 38 - base cm 27x51
peso kg 42
92.59 lbs - 30.31" tall - 14.96 dia
10.62" L - 20.07" W





Art 10045
COPPIA BASE CORTENSE

h cm 73 - lungh. cm 60 - profondità cm 30
peso kg 70
154 lbs - 28.7" tall



Art 10047
1/2 COLONNA CAMILLA

h cm 74 - base cm 20x38
peso kg 28
61.72 lbs - 29.13" tall
7.87" L - 14.96" W

Art 10049
1/2 CAPITELLO CAMILLA

h cm 45 - base cm 18x36
peso kg 20
44.09 lbs - 17.71" tall
7.08" L - 14.17" W



Art 10151
VASO TRIFOGLIO

h cm 55 - Ø cm 45 - base cm 22x22
peso kg 16
35.27 lbs - 21.65" tall - 17.71" dia
8.66" L - 8.66" W



Art 10983
**FONTANA
CHIANCIANO**

h cm 125x50x56
peso kg 50
110.23 lbs - 49.21" tall
19.68" L - 22.04" W





Art 10114
**PORTAVASO CALICANTUS
GRANDE**

h cm 80 - Ø cm 48
peso kg 44
95.5 lbs - 31.5" tall - 18.9" dia



Art 10163
**VASO VELLO D'ORO
DELL'ARIETE**

h cm 78 - Øcm 70
base cm 33x33 - peso kg 66
145 lbs - 30.7" tall - 27.5" dia
13" L - 13" W

Art 10693
BASE ZEUS PICCOLA

h cm 76 - base cm 53x53
peso kg 103
230 lbs - 29.9" tall
20.9" L - 20.9" W

Art 10208
ANFORA ARIETE

h cm 93 - Ø cm 48
base cm 30x30 - peso kg 50
110 lbs - 36.6" tall - 18.9" dia
11.8" L - 11.8" W

Art 10674
BASE ACESTE

h cm 50x40x40 - peso kg 30
65 lbs - 19.7" tall - 15.7" L - 15.7" W



Art 10370
FIORIERA ZINIA P.

h cm 45 - lung. cm 67x45
peso kg 25
55 lbs - 17.7" tall
26.4" L - 17.7" W



11

Design Antiquariato



Art 10225
ANFORA ITALIA

h cm 158 - Ø cm 80
base cm 50x50 - peso kg 206
455 lbs - 62.2" tall - 31.5" dia
16.6" W - 19.6" L

Art 10696
BASE UNIVERSALE

h cm 86 - largh. cm 50x50
peso kg 100
220 lbs - 33.9" tall
19.7" L - 19.7" W



Art 10513
GIULIETTA E ROMEO

h cm 142 - base cm 70x42
peso kg 145
318 lbs - 55.9" tall
27.6" L - 15.5" W

Art 10694
BASE ACASCIA

h cm 32 - largh. cm 90x50
peso 53
118 lbs - 12.6" tall
35.4" L - 19.7" W



13

Design Antiquariato



Art 10414
NIKE DI SAMOTRACIA
h cm 155 - largh. cm 91
base diam. cm 40
peso kg 125
551 lbs - 61.02" tall

Art 10689
BASE PLINIO
h cm 58 - Ø cm 47
peso kg 38
83 lbs - 22.8" tall
22.4" dia



Art 10437
PAOLINA GRANDE

h cm 165 - base Ø cm 38
peso kg 95
214 lbs - 65.00" tall

Art 10689
BASE PLINIO

h cm 58 - Ø cm 47
peso kg 38
83 lbs - 22.8" tall - 22.4" dia



15

Design Antiquariato



INVERNO



AUTUNNO



ESTATE



PRIMAVERA

Art 10427

**SERIE
QUATTRO STAGIONI**

h cm 125 - base cm 34x34

peso kg 245

528 lbs - 49.2" tall

13.3" L - 13.3" W

Art 10693

BASE ZEUS PICCOLO

h cm 76 - base cm 53x53

peso kg 103

230 lbs - 29.9" tall

20.9" L - 20.9" W



17

Design Antiquariato

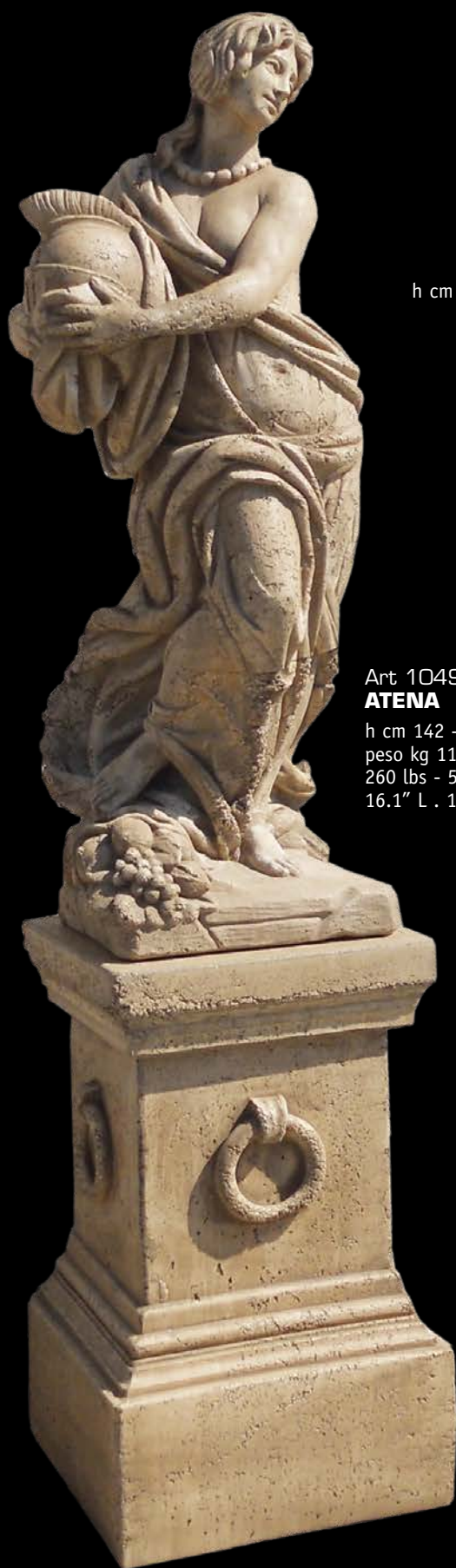

Art 10495
ATENA
h cm 142 - base cm 41x44
peso kg 118
260 lbs - 55.9" tall
16.1" L . 17.3" W



Art 10497
MARTE
h cm 152 - base cm 41x44
peso kg 103
225 lbs - 58" tall
16.1" L - 17.3" W

Art 10686
BASE ZEUS GRANDE
h cm 87 - capitello cm 51x51
peso kg 120
265 lbs - 34.3" tall



Art 10616
COPPIA LEONI TANAGRA

h cm 47 - lungh. cm 83x34
peso kg 105
261 lbs - 18.5" tall

Art 10694
BASE ACASCIA

h cm 32 - largh. cm 90x50
peso kg 53
116 lbs - 12.6" tall - 35.4" L - 17.7" W



Art 10605
COPPIA LEONI EGIZI

h cm 65 - lungh. cm 75x32
peso kg 130
286 lbs - 25.6" tall

Art 10694
BASE ACASCIA

h cm 32 - largh. cm 90x50
peso kg 53
118 lbs - 12.6" tall
35.4" L - 19.68" W



19

Design Antiquariato

Art 10799/B
ARCHITRAVE TYPE B
Lungh. cm 225 - h cm 20x25
peso kg 110
88.58" L

Art 10799
ARCHITRAVE TYPE A
Lungh. cm 200 - h cm 20x25
peso kg 100
78.74" L



Art 10808
**COLONNA
GALLIPOLI**

h cm 238
base cm 50x50
peso kg 170
375 lbs - 90.6" tall
19.7" L - 19.7" W

Art. 10495
Athena

Art. 10686
Base Zeus G.

Art 10799/C
ARCHITRAVE TYPE C
Lungh. cm 250 - h cm 20x25
peso kg 120
98.42" L



Art. 10497
Marte



21

Design Antiquariato

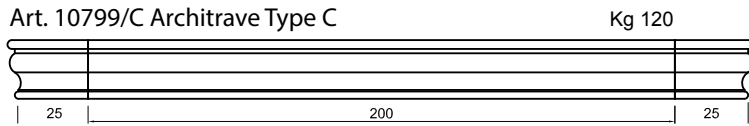
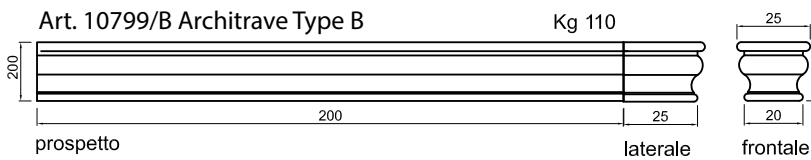
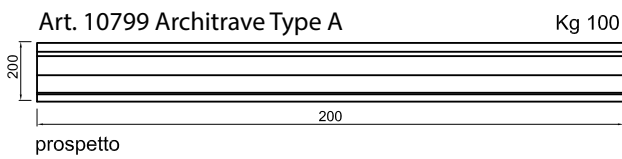
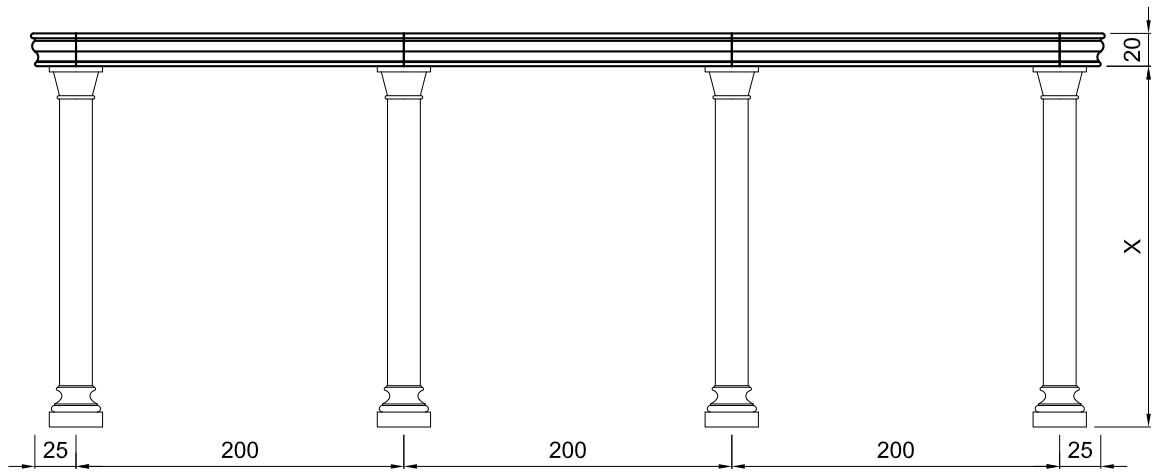

FIX KIT: n.1 placca di fissaggio
 NOT n. 2 fisher
 INCLUDED n. 1 rondella
 n. 1 dado
 50 cm, barra filettata

SCHEMA DI
 MONTAGGIO
 ASSEMBLING
 DIAGRAM

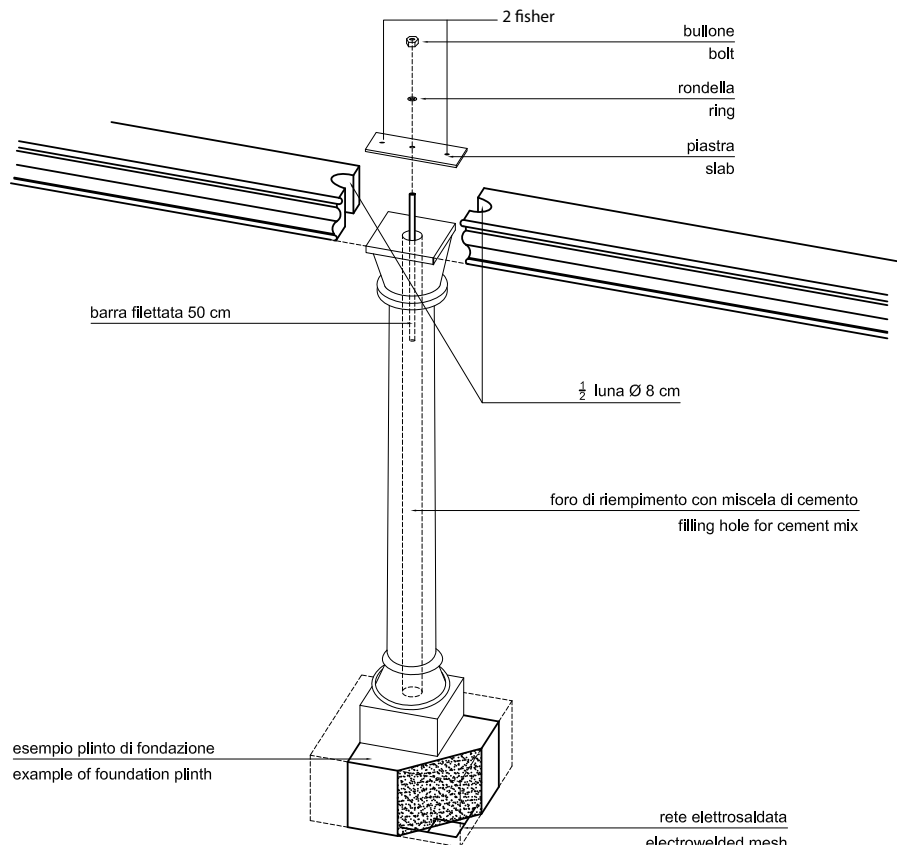



Art 10706
BUSTO GIULIO CESARE

h cm 70 - largh. cm 47
base Ø cm 23
peso kg 22
48.50 lbs - 27.55" tall
9.05" dia



Art 10708
BUSTO APOLLO

h cm 76 - largh. cm 47
base Ø cm 23
peso kg 30
66.13 lbs - 29.92" tall
9.05" dia

Art 10768
COLONNETTA ASMARA

h cm 95 - base cm 31x31
capitello cm 25x25
peso kg 31
68.34 lbs - 37.40" tall
12.20" L - 12.20" W

Art 10417
BASE EGEO

h cm 45 - base cm 27x27
peso kg 29
63.93 lbs - 17.71" tall
10.62" L - 10.62" W



23

Design Antiquariato



ITALART

Sede e uffici: Via Papa Boncaldi, 2
Stabilimento: Via Prati Magri, 9

05022 Alpa (Sp) - Tel. (+39) 050.948135 - Fax (+39) 050.946135
WWW.ITALARTWORLD.COM

Web site: www.italartworld.com 1.800.515.1977
E-mail: info@italartworld.com 046.505.2722

tel. +39 050 948135 - fax +39 050 946135